

P1 橋脚配筋図 (その2) S=1:50

8 - 8

9 - 9

10 - 10

11 - 11

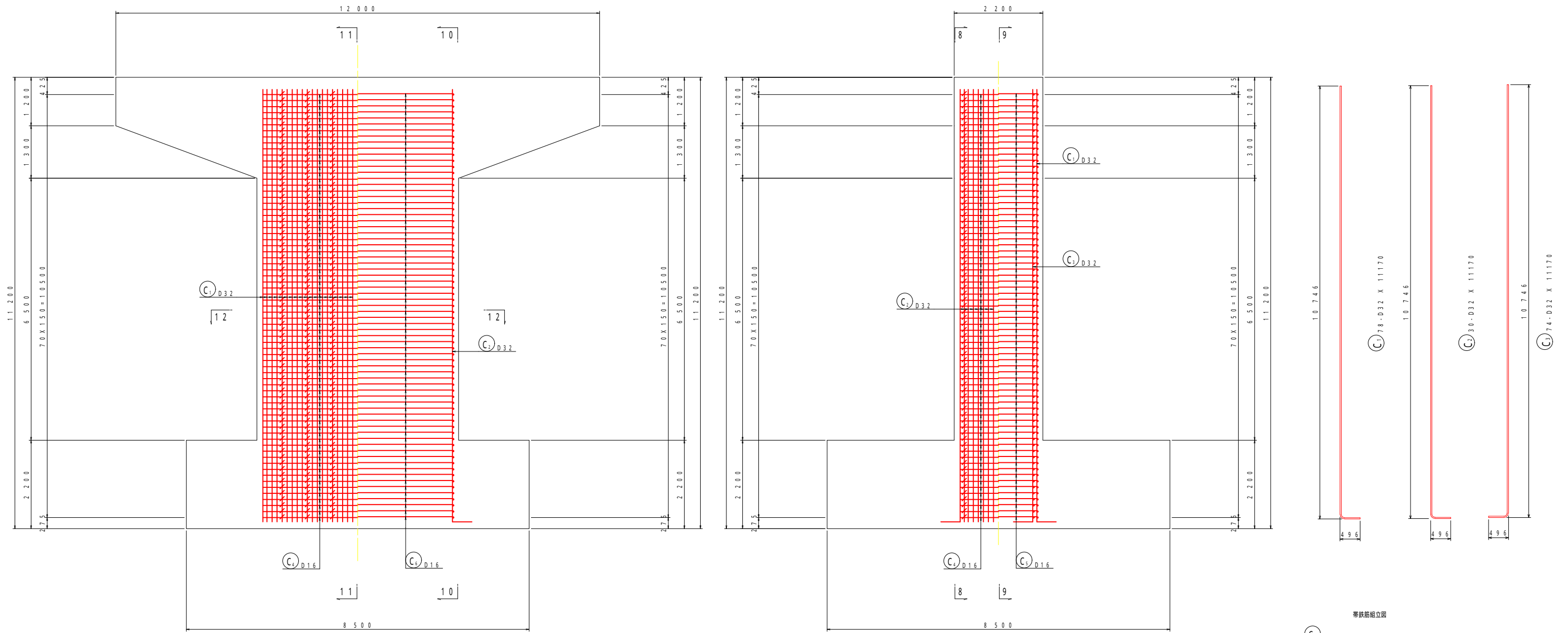

柱詳細図 S=1:20

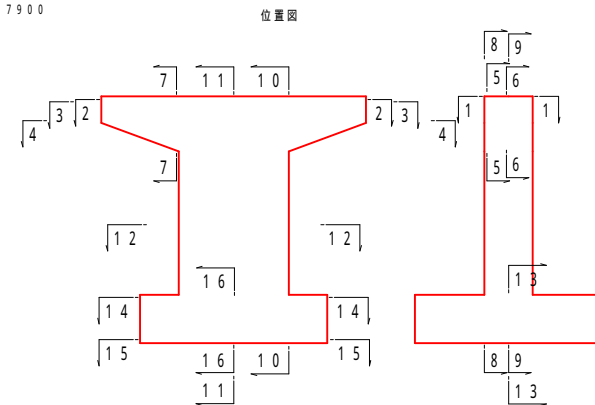
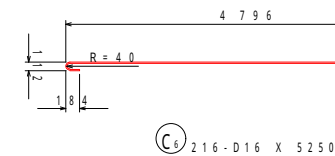
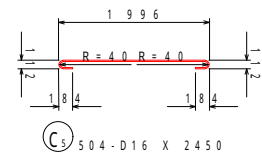
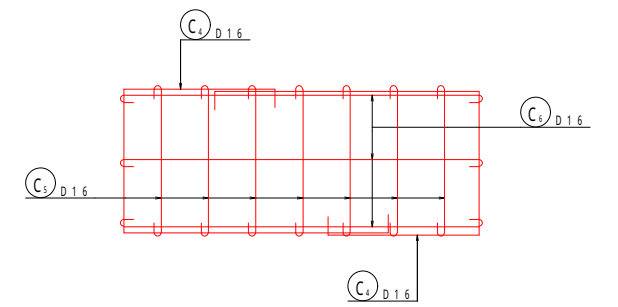
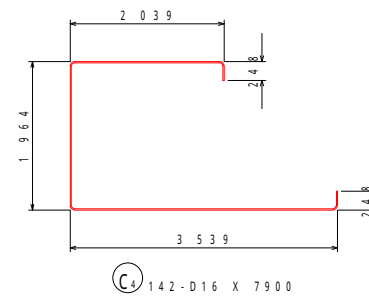
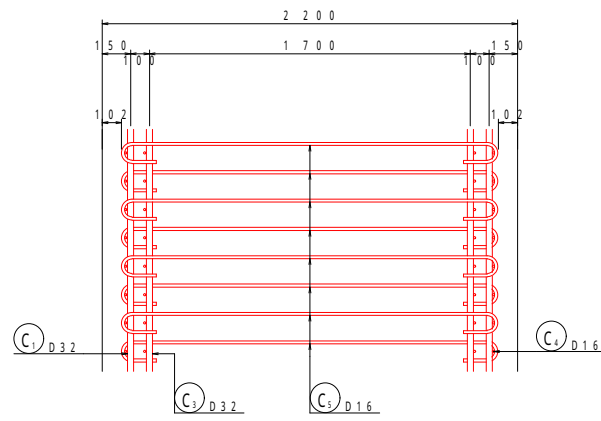
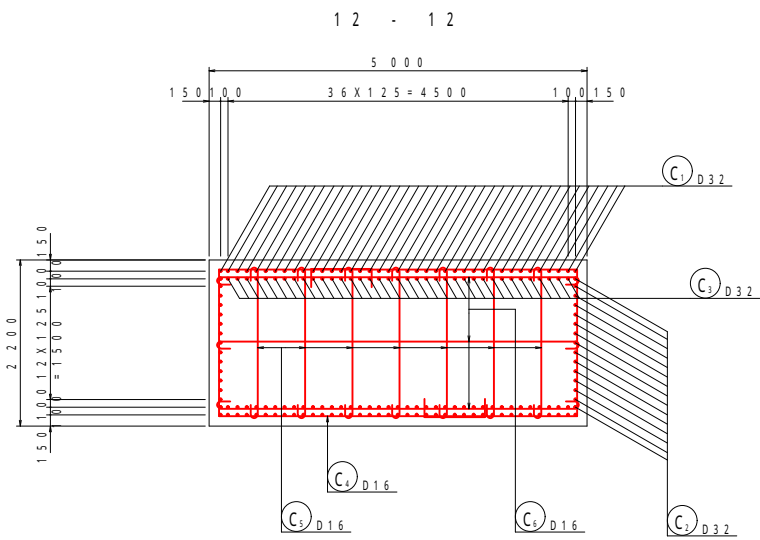

帯鉄筋組立図

工事名	
図面名	
尺度	
年月日	図面番号 業之内
会社名	
事務所名	

P1橋脚配筋図(その3) S=1:50

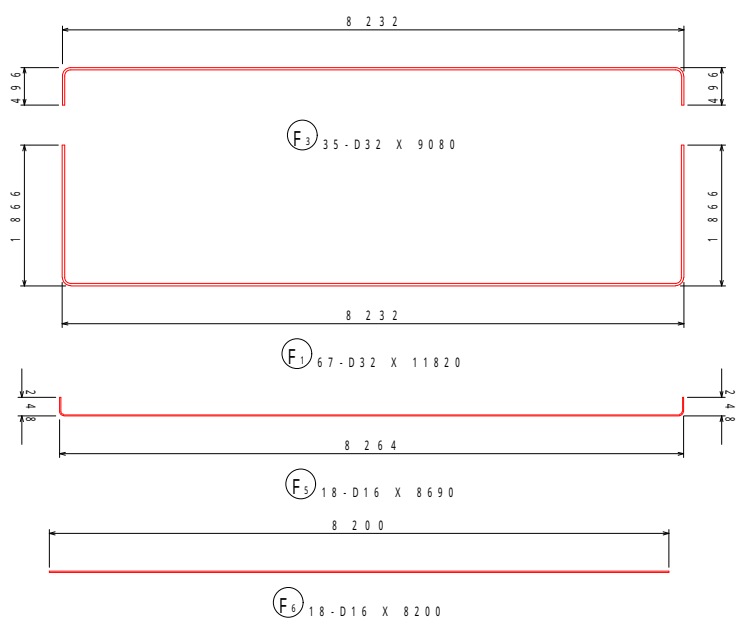
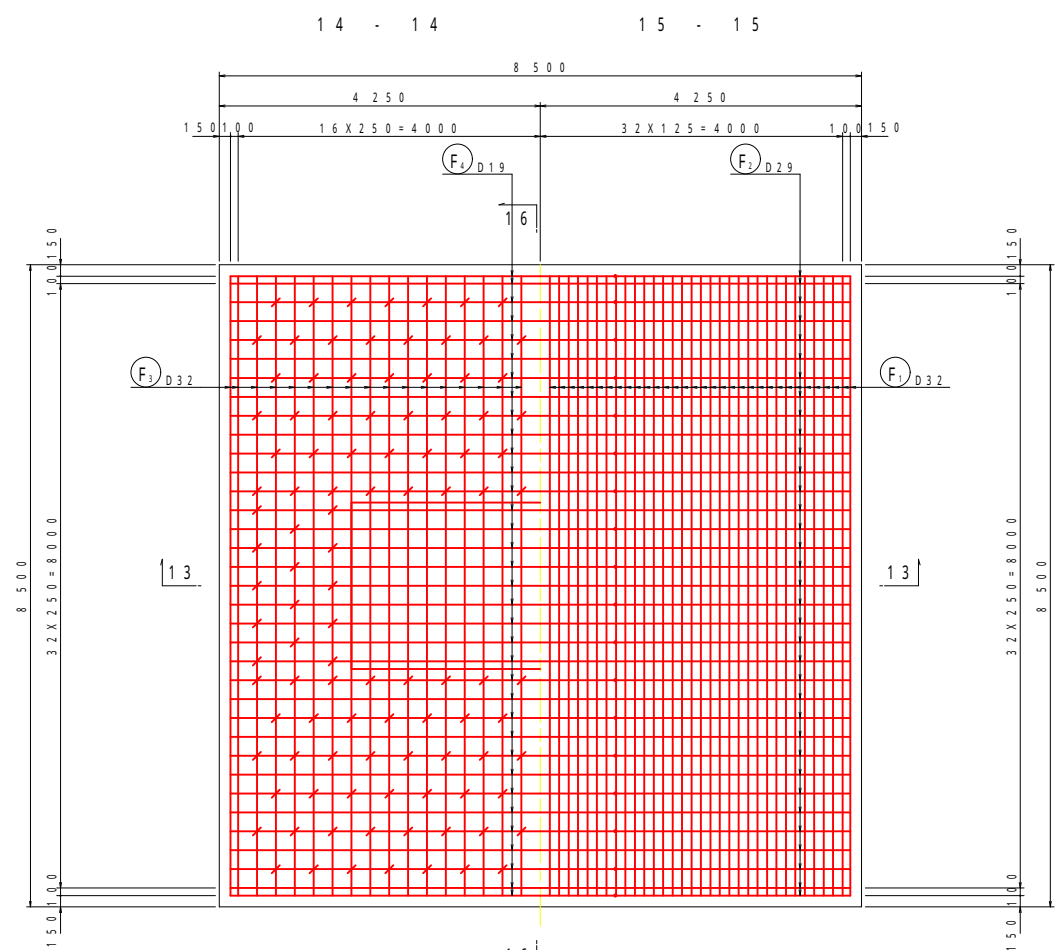
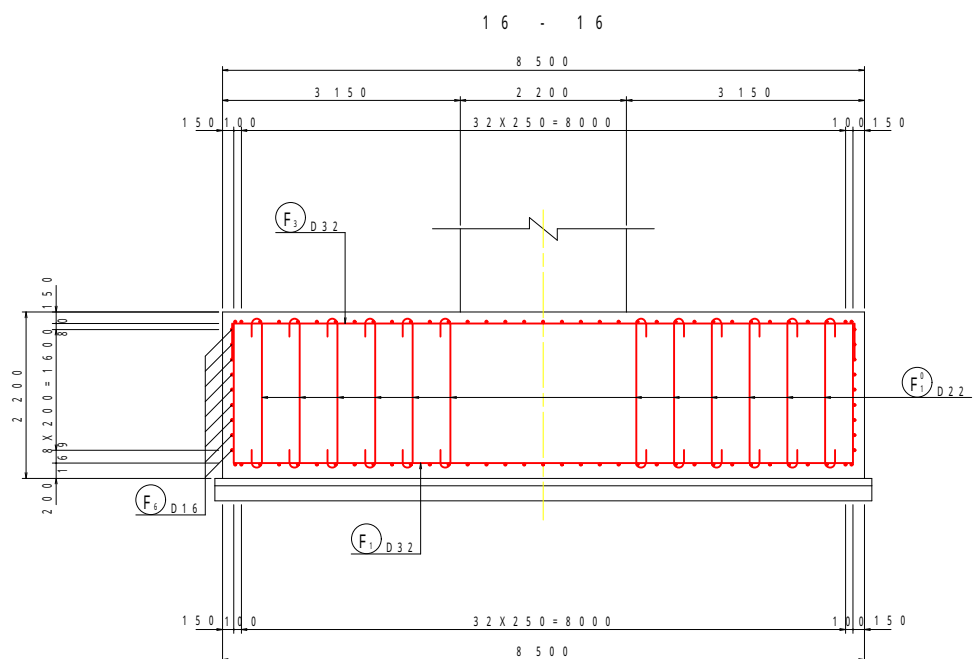
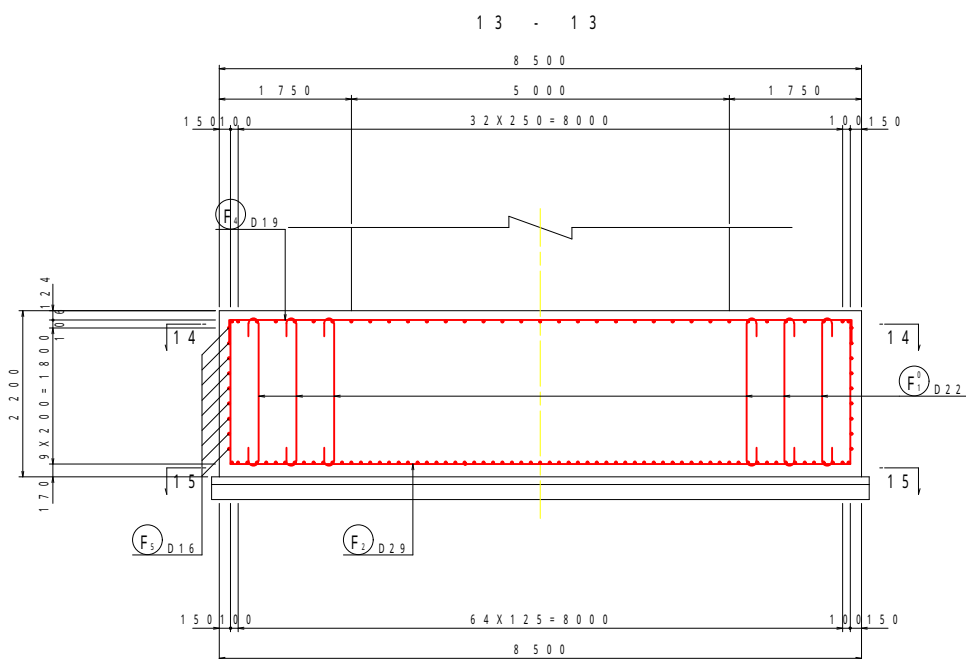

底板詳細図 S=1:20

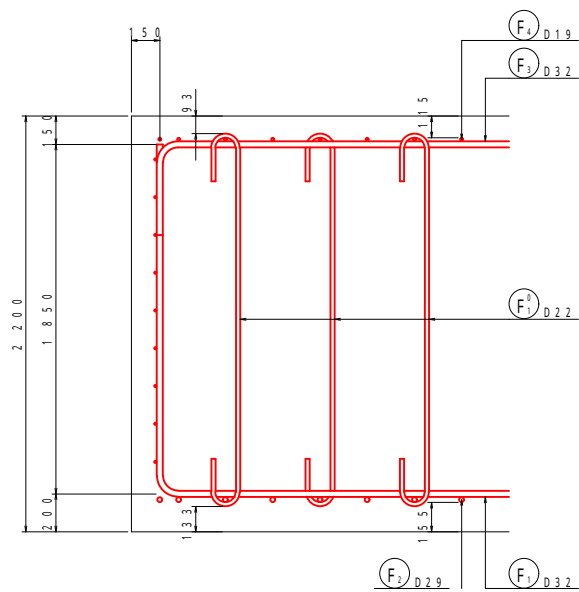

鉄筋質量表

種別	径	長さ	本数	単位質量	一本当り質量	質量	摘要
B 1-1	D32	7 000	15	6.23	43.610	654.150	(15)
B 1-2	D32	5 680	15	6.23	35.386	530.790	
B 2-1	D32	7 000	15	6.23	43.610	654.150	(15)
B 2-2	D32	5 480	15	6.23	34.140	512.100	
B 3	D29	5 990	30	5.04	30.190	905.700	
B 4	D16	11 800	10	1.56	18.408	184.080	
B 5	D16	2 410	10	1.56	3.760	37.600	
B 6	D16	8 500	18	1.56	13.260	238.680	(平均長)
B 7	D22	5 860	42	3.04	17.814	748.188	(平均長)
B 8	D22	7 180	16	3.04	21.827	349.232	
B 9	D22	3 510	17	3.04	10.670	181.390	
B 10	D22	2 660	58	3.04	8.086	468.988	
B 11	D22	5 150	42	3.04	15.656	657.552	(平均長)
B 12	D22	6 460	16	3.04	19.638	314.208	
B 13	D16	2 520	75	1.56	3.931	294.825	
6 731.633							
H 1	D16	1 960	55	1.56	3.058	168.190	
H 2	D16	1 760	65	1.56	2.746	178.490	
H 3	D16	5 550	5	1.56	8.658	43.290	
389.970							
C 1	D32	11 170	78	6.23	69.589	5 427.942	
C 2	D32	11 170	30	6.23	69.589	2 087.670	
C 3	D32	11 170	74	6.23	69.589	5 149.586	
C 4	D16	7 900	142	1.56	12.324	1 750.008	
C 5	D16	2 450	504	1.56	3.822	1 926.288	
C 6	D16	5 250	216	1.56	8.190	1 769.040	
18 110.534							
F 1	D32	11 820	67	6.23	73.639	4 933.813	
F 2-1	D29	7 000	35	5.04	35.280	1 234.800	(35)
F 2-2	D29	4 940	35	5.04	24.898	871.430	
F 3	D32	9 080	35	6.23	56.568	1 979.880	
F 4	D19	8 730	35	2.25	19.643	687.505	
F 5	D16	8 690	18	1.56	13.556	244.008	
F 6	D16	8 200	18	1.56	12.792	230.256	
F 7	D22	2 590	214	3.04	7.874	1 685.036	
11 866.728							
(圧接箇所)							
合計	D32		21 930		0.81 kg	(30)	
	D29		3 011		9.30 kg	(35)	
	D22		4 404		5.94 kg		
	D19		687		5.05 kg		
	D16		7 064		7.55 kg		
総質量					37 098.865 kg	(65)	

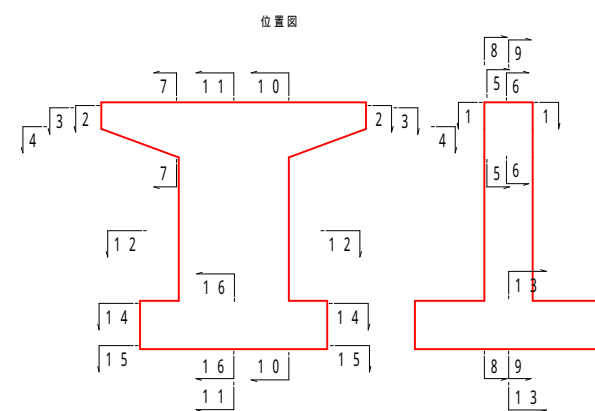

工事名		
図面名		
尺度		
年月日	図面番号	業之内
会社名		
事務所名		